

Fasteners

Introduction

Slot nuts

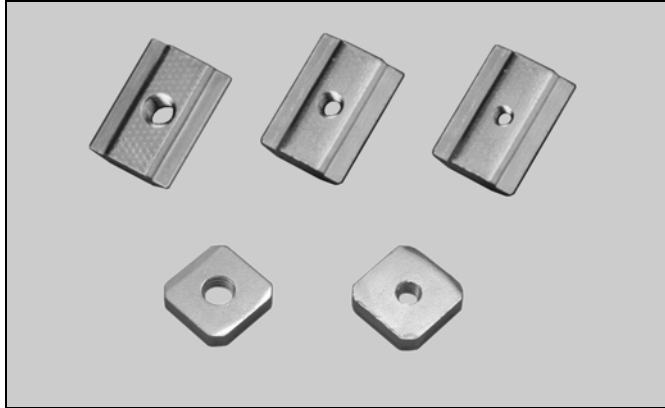

Slot nuts are used for connections to the structural system T-slots. The nuts exist in XC and XF versions.

Screws, nuts and washers



This catalogue lists a number of standard screws, nuts and washers which are needed frequently when building structural system applications.

Locking levers are recommended replacements for screws or nuts when frequent readjustment of a screw/nut connection are needed.

PO

XS

XL

XL P

X85

X85 P

XH

XK

XK P

XB

GR

CS

XT

XC

XF

FST

XMY

XLX

XXM

GRX

CSX

ELV

CTL

TR

APX

IDX

Hex head bolt – ISO 4014/4017

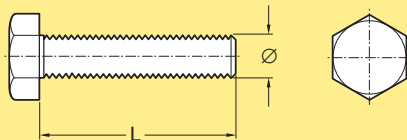

Hex head screw – ISO 4014/4017

M5, L=12 mm, Ø5 mm	M6S 5×12
M8, L=12 mm, Ø8 mm	M6S 8×12 A4*
M8, L=14 mm, Ø8 mm	M6S 8×14
M8, L=16 mm, Ø8 mm	M6S 8×16
M8, L=18 mm, Ø8 mm	M6S 8×18
M8, L=20 mm, Ø8 mm	M6S 8×20 A4*
M8, L=25 mm, Ø8 mm	M6S 8×25 A4*
M8, L=30 mm, Ø8 mm	M6S 8×30
M8, L=40 mm, Ø8 mm	M6S 8×40 A4*
M8, L=45 mm, Ø8 mm	M6S 8×45 A4*

Note. Must be ordered in multiples of 50

*Stainless steel

Hex socket head cap screw, ISO 4762

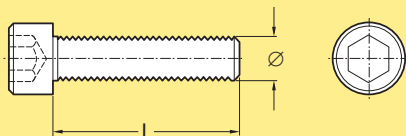

Hex socket head screws, standard – DIN 912, ISO 4762

M5, L=12 mm, Ø5 mm	MC6S 5×12
M5, L=20 mm, Ø5 mm	MC6S 5×20
M5, L=35 mm, Ø5 mm	MC6S 5×35
M6, L=14 mm, Ø6 mm	MC6S 6×14
M6, L=16 mm, Ø6 mm	MC6S 6×16
M6, L=16 mm, Ø6 mm	MC6S 6×16 A4*
M6, L=25 mm, Ø6 mm	MC6S 6×25 A4*
M6, L=30 mm, Ø6 mm	MC6S 6×30
M6, L=50 mm, Ø6 mm	MC6S 6×50
M8, L=14 mm, Ø8 mm	MC6S 8×14
M8, L=30 mm, Ø8 mm	MC6S 8×30

Note. Must be ordered in multiples of 50

*Stainless steel

Hex head cap screw, low head DIN 7984

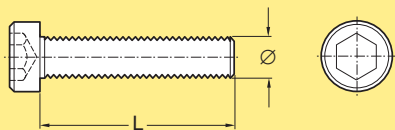

Hex socket head screw, low profile – DIN 7984

M5, L= 8 mm, Ø5 mm	MLC6S 5×8
M5, L=10 mm, Ø 5 mm	MLC6S 5×10
M5, L=20 mm, Ø 5 mm	MLC6S 5×20
M6, L=12 mm, Ø 6 mm	MLC6S 6×12
M8, L=14 mm, Ø 8 mm	MLC6S 8×14
M8, L=30 mm, Ø 8 mm	MLC6S 8×30
M8, L=35 mm, Ø 8 mm	MLC6S 8×35

Note. Must be ordered in multiples of 50

Hexagon socket countersunk head screw ISO 10642

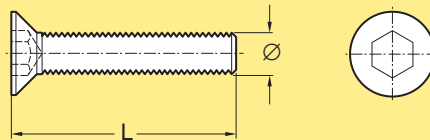

Hex socket head screw, countersunk – DIN EN ISO 10642

M6, L=12 mm, Ø6 mm	MF6S 6×12
M6, L=14 mm, Ø6 mm	MF6S 6×14
M6, L=16 mm, Ø6 mm	MF6S 6×16
M6, L=30 mm, Ø6 mm	MF6S 6×30
M8, L=18 mm, Ø8 mm	MF6S 8×18
M8, L=30 mm, Ø8 mm	MF6S 8×30
M8, L=40 mm, Ø8 mm	MF6S 8×40

Note. Must be ordered in multiples of 50

Selftapping screw, countersunk DIN 7500- ME

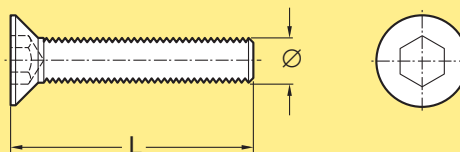

Selftapping screw M8, L=30 mm, Ø8 mm Countersunk

MF6S-TT 8×30

Note. Must be ordered in multiples of 50

Selftapping screw, hex socket head DIN 7500- EE

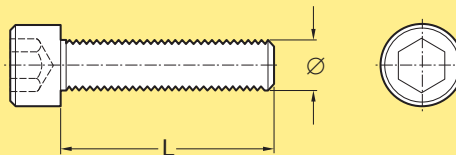

Selftapping screw M6, L=30 mm, Ø6 mm Hex socket head

MC6S-TT 6×30

Note. Must be ordered in multiples of 50

T-bolt for conveyor beam

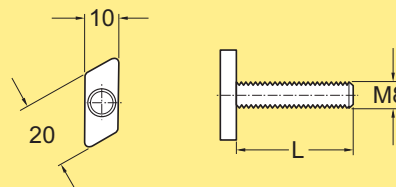

T-bolt M8

L= 17,8 mm	XLAT 17
L= 24 mm	XLAT 24
L= 35 mm	XLAT 35
L= 53 mm	XLAT 53
L= 71 mm	XLAT 71

Note. Must be ordered in multiples of 50

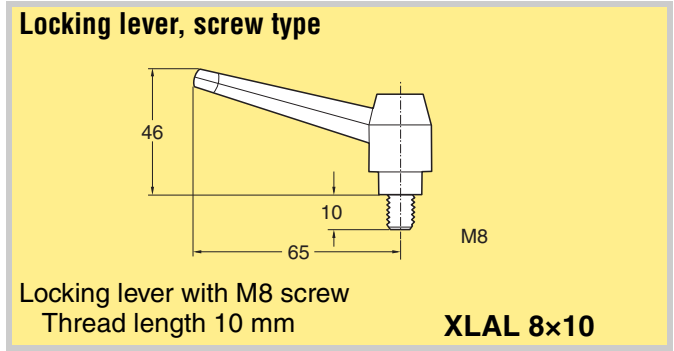

- PO
- XS
- XL
- XLP
- X85
- X85P
- XH
- XK
- XKP
- XB
- GR
- CS
- XT
- XC
- XF
- FST**
- XMY
- XLX
- XXM
- GRX
- CSX
- ELV
- CTL
- TR
- APX
- IDX

Washers

Washers

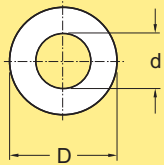

Flat washer

For M5, d=5,3 mm, D=10 mm	BRB 5,3×10
For M6, d=6,4 mm, D=12 mm	BRB 6,4×12
For M6, d=6,4 mm, D=12 mm	BRB 6,4×12 A4*
For M8, d=8,4 mm, D=16 mm	BRB 8,4×16
For M8, d=8,4 mm, D=16 mm	BRB 8,4×16 A4*
For M8, d=8,4 mm, D=24 mm	BRB 8,4×24 A4*

Note. Must be ordered in multiples of 50

**Stainless steel*

Nuts, locking lever of nut type

Nut for T-bolt DIN 985:1987 Class 8

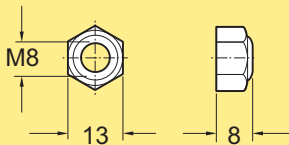

Locking nut M8 for T-bolt **XLAN 8**
 Locking nut M8 for T-bolt **XLANX 8***

Note. Must be ordered in multiples of 50

**Stainless steel*

T-slot nut for System XF T-slot

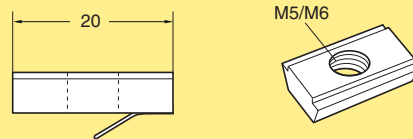

T-slot nut for XF
 Steel, zinc-chromated
 M5 **XFAN 5***
 M5, multipack (500 pcs) **5056131**
 M6 **XFAN 6***
 M6, multipack (500 pcs) **5056130**

**Note. Must be ordered in multiples of 10*

Nut – ISO 4032

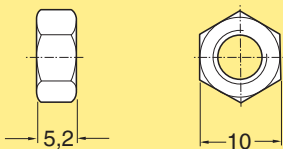

M6 nut **M6M M6**
 M6 nut, stainless steel **M6M M6 A4**

Note. Must be ordered in multiples of 50

T-slot nut for System XC T-slot

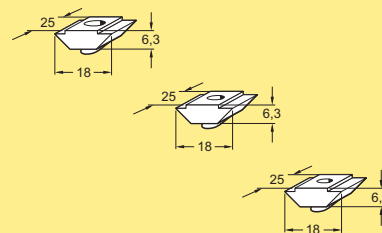

T-slot nut for XC
 Steel, zinc-chromated
 M5 **XCAN 5***
 M5, multipack (250 pcs) **5056129**
 M6 **XCAN 6***
 M6, multipack (250 pcs) **5056128**
 M8 **XCAN 8***
 M8, multipack (250 pcs) **5056127**

**Note. Must be ordered in multiples of 10*

Square nut for System XC T-slot

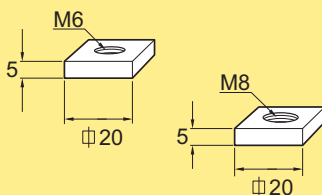

Square nut for XC
 M8 thread **XLAQ 8**
 M6 thread **XLAQ 6**

Note. Must be ordered in multiples of 50

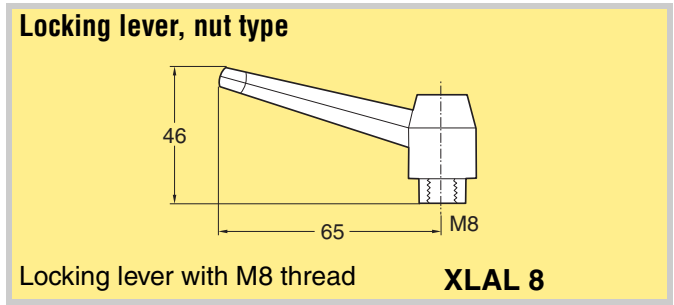

PO

XS

XL

XL P

X85

X85 P

XH

XK

XK P

XB

GR

CS

XT

XC

XF

FST

XMY

XLX

XXM

GRX

CSX

ELV

CTL

TR

APX

IDX

