



Product Overview:

The WEP-80 wide belt elevating prefeeder is specially designed to handle large parts. Two independently controlled variable speed drives ensure gentle product metering. Designed for floor level parts loading, the 80 ft³ capacity hopper delivers product at an average belt speed of 23 feet per minute. The cleated elevator belt has a nominal cleat height of 4" and a cleat pitch of 12", allowing for maximum product loading. Note: Controllers and mechanical level sensors are not supplied with this unit.

Part Number	WEP80XXDSA	WEP80XXASA
Motor Style	DC	AC
Motor Voltage	90V	230/460V
Horsepower (Horizontal)	1/2hp	1/2hp
Horsepower (Elevator)	1/2hp	1/2hp
Total Equipment Weight	2462 lbs.	1117 kg
Hopper Capacity	80 ft ³	2266 liters

Standard Features:

- Stainless steel construction
- Sensor controlled dual belt metering system
- Horizontal belt is FDA/USDA approved white buna-n/polyester polyflake endless belting
- Elevator belt is FDA/USDA approved white 1-ply solid woven polyester fabric with .156" thick white PVC coating and PVC cleats

Available Options:

- Elevator extensions*
- Continuous welded hopper seams
- Elevator/Hopper covers
- Washdown motor
- NEMA 1 encased controller
- Clean out doors
- Casters

* It is strongly recommended that the frame of the prefeeder be reinforced and/or additionally supported for elevator extensions of 72" or greater.

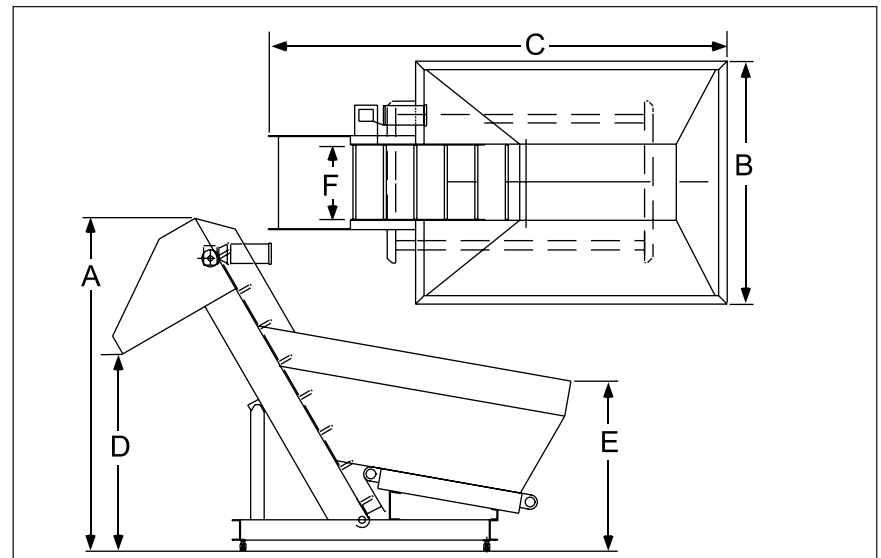

Product Specifications	ANSI	Metric
A Overall Height	100"	2540mm
B Overall Width	72"	1829mm
C Overall Length	136"	3454mm
D Discharge Height	60"	1524mm
E Hopper Load Height	50"	1270mm
F Belt Width (Elevator)	22"	559mm

Headquarters
13129 Airpark Drive
Suite 120
Elkwood, VA 22718
540.829.2564 t
800.368.3582 t
540.829.1726 f

Sales
1445 Brookville Way
Suite F
Indianapolis, IN 46239
317.322.0754 t
800.368.3582 t
317.322.0794 f

Manufacturing
291 Dillard Road
Madison Heights, VA
24572
434.929.4746 t
800.543.0915 t
434.929.4959 f

Shibuya Hoppmann Corporation strives to improve its products and reserves the right to change or discontinue specifications & designs shown in this brochure without notice and without incurring obligation. Revised: 05/12.